



Measurements International

Metrology is Our Science, Accuracy is Our Business™

ACCUBRIDGE® 6020A High Current Systems

High Precision DCC Shunt & DCC Measurement Systems



6020/3000 A Shown

Featuring

- ▶ Modular Designed Base Unit with Expanded Capabilities to 10,000 Amp
- ▶ Ratio Ranges: 1 to 1,000,000:1
- ▶ Complete Turn-key Systems
- ▶ Resistance and Temperature Curves
- ▶ Linearity < 0.01 ppm
- ▶ Complete Measurement Systems Available
- ▶ Proven Technology

Overview

Measurements International's (MI) series of Shunt Measurement Systems offers the best accuracy and lowest uncertainty of any commercial system available on the market today. The MI High Current Range Extenders expand the measuring capabilities of the MI 6020 to measure lower resistance values at higher current.

The MI 6020 series of Shunt Measurement Systems provide the widest range with the lowest uncertainty of any manufacturer. System accuracy: < 2 ppm compared to 15 ppm from our nearest competitor.

Feature	Benefit
DCCT based	Provides excellent stability and range linearity
Multiple current ranges available	Flexibility to target the measurements you need
Extremely low uncertainty	Allows sub-ppm high current measurements
Modular proven design	System capabilities can be expanded or reduced as necessary
Oversized current terminals	Reduces temperature errors on UUT
Multiple uses	Use for DCCT or shunt calibration or stand-alone power supply
Independent operation	Can be used as DC current divider



ACCUBRIDGE® 6020A High Current Systems

Measurements International is the original manufacturer of the Automated Resistance Measurement System. With the most current comparator experience in the industry, Measurements International's Shunt Measurement Systems are designed using sound metrology principles. As your accreditation partner and global support partner, MIL offers leading product knowledge and applications expertise through coaching, system design, implementation, calibration services and ongoing expert support, which assures your competitive advantage with all your MI products.

At MIL, it's not only about the equipment or the science... it's about what it will enable you to do, and the ease with which you can do it.

The MI series of 6020 Bridges and Shunt Measurement Systems are used by the majority of National Measurement Laboratories and military labs worldwide as well as the US Air Force, US Army, and US Navy.

Other manufacturers also claim to have the best accuracy and meet the military requirements for resistance measurements yet are unable to compare to Measurements International.

Don't be fooled or misled by other manufacturers' claims, ask for references and consult any NMI in regards to modern resistance measurement systems.

Ratio Range	Resistance	Max Current	Accuracy
	Ω	A	ppm
10	0.1	1	0.2
100	0.01	10	0.3
1000	0.001	100	0.4
10,000	0.0001	1000	2
100,000	0.00001	3000	2
1,000,000	0.000001	5000	5
1,000,000	0.0000001	10,000	10

Standard resistors of 1 Ω , 10 Ω , and 100 Ω may also be used to extend the ratio for higher currents. For example, if you had a 0.01 Ω shunt at 100 A it could be measured on the 100 A range using a 10 Ω standard or if you had a 0.1 Ω shunt at 15 A you can measure it on the 100 A range using a 100 Ω standard.

Resistance/Temperature and Time/Temperature Curves

All the MI High Current Shunt Measurement Systems have the capability of providing both the resistance/temperature curve as well as the time/temperature curve for the shunt being measured, a feature that only MI offers. The resistance temperature curve is found measuring the shunt at several different current levels and plotting the equilibrium points. This type of curve determines the characteristics of the shunt when heat is dissipated by the shunt elements and is modelled by a second-order polynomial. Equilibrium is obtained when the temperature and resistance of the shunt reach a steady state at the current level being measured. Once the resistance/temperature equilibrium curve has been established the shape will not change, but the resistance will drift as a typical resistance standard. In addition, environmental temperature, pressure and humidity can be measured and logged with shunt data.

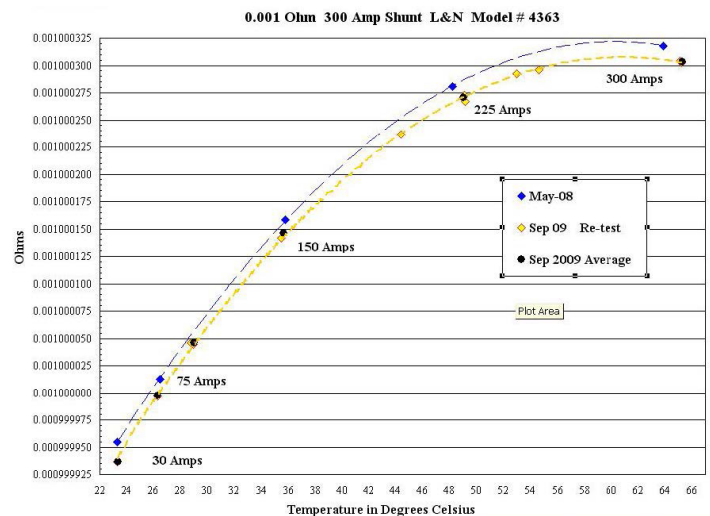



ACCUBRIDGE® 6020A & 6242D High Current Systems

MI Series of DCC Range Extenders

6511 DCC Range Extender with Built-in Power Supply

The 6511 was designed for users who do not require high currents but still need the best accuracy for their measurements. Three (3) ratios of 10, 100, and 1000 and a built-in linear power supply of 10 A are provided for the measurements of 0.1 Ω, 0.01 Ω, and 0.001 Ω current resistors or shunts. The maximum output current of the 6511 is 100 mA for ratios 10 (1 A) and 100 (10 A) and 10 mA for ratio 1000 for 10 A in.

6511 Ranges	10 ⁻³ :1	10 ⁻² :1	10 ⁻¹ :1
6511 Uncertainties	0.4	0.3	0.3
6020/6511 Uncertainties	0.41	0.31	0.31

6011/150 A DCC Range Extender

The 6011 is a precision DC Current Range Extender for currents up to 150 A. Using innovative technological improvements to the direct current comparator, the linearity specification has been improved to less than 0.01 ppm over its entire range. The 6011 can be used as a stand-alone unit for dividing high currents down to workable levels. The full-scale output current of the 6011 is 150 mA on all ranges. Applications include calibration of DC current sources and in DCC shunt measurement systems.

The 6011/150 has a built-in reversing switch and automatic ranging of the 1, 10, and 150 A ranges. As a standalone unit applications include calibration of DC current sources up to 150 A, all that is required is a DVM to measure the voltage across a standard resistor connected to the 6011 output and any power supply can be calibrated easily and efficiently.

Ranges	10 ⁻³ :1	10 ⁻² :1	10 ⁻¹ :1
Currents	150 A	10 A	1 A
6011/100 Uncertainties	0.4 ppm	0.3 ppm	0.2 ppm



6511D Automated Range Extender



6011D 150 Ampere Range Extender

Ranges	10 ⁻⁶ :1	10 ⁻⁵ :1	10 ⁻⁴ :1	10 ⁻³ :1	10 ⁻² :1	10 ⁻¹ :1
Currents	100	100	100	100	10	1
6020/6011/150 Uncertainties	2 ppm	2 ppm	1 ppm	0.41 ppm	0.31 ppm	0.21 ppm



ACCUBRIDGE® 6020A High Current Systems

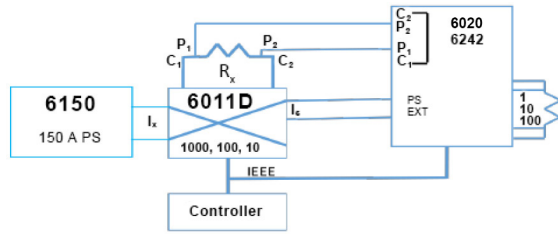

Shunt Calibration 6020/6011

When used in the shunt measurement system, the system can be automated using a controller and the model 6150/150 DC Power Supply.

The system can be powered from a 100 V, 120 V, 220 V or 240 V single-phase supply. There is no requirement for special cooling or heat exhausts providing flexibility for room locations. Mounted on wheels the 6020/150 can be moved about easily when required.

When mounted in the rack, a shunt connection is made easily from the front of the rack. Installation and operation are easy when used with the 6010 or 6242 Resistance Bridges.

6011/300 DCC Range Extender

The 6011/300 is a precision DC Current Range Extender for currents up to 300 A. Using the same innovative technological improvements as used in the 6011/150 direct current comparator, the linearity specification has been improved to less than 0.01 ppm over its entire range. The full-scale output current of the 6020/300 system is 100 mA on all ranges.

The 6011/300 has a built-in reversing switch and automatic ranging of the 3 A, 30 A and 300 A. As a standalone unit, the 6011/300 can be used to calibrate DC current sources up to 300 A. All that is required is a DVM to measure the voltage across a standard resistor connected to the 6011/300 output and any power supply can be calibrated easily and efficiently.



6511D/300 A Range Extender

Ranges	10 ⁻³ :1	10 ⁻³ :1	10 ⁻² :1	10 ⁻¹ :1
Currents	300	100	10	1
6011/300 Uncertainties	0.4 ppm	0.4 ppm	0.3 ppm	0.2 ppm

When used in the 6020/300 Shunt Measurement System, the system can be automated using a controller and (2) 6150A DC Power Supplies.

Ranges	10 ⁻⁶ :1	10 ⁻⁵ :1	10 ⁻⁴ :1	10 ⁻³ :1	10 ⁻² :1	10 ⁻¹ :1
Currents	300	300	300	100	10	1
6020/6011/300 Uncertainties	2 ppm	2 ppm	1 ppm	0.41 ppm	0.31 ppm	0.21 ppm

The system can be powered from a 100 V, 120 V, 220 V or 240 V single-phase supply. There is no requirement for special cooling or heat exhausts providing flexibility for room location. Mounted on wheels, the 6020/300 can be moved about easily when required.

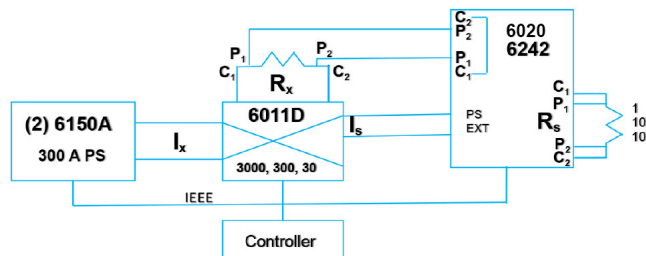

6020/300 A Schematic



ACCUBRIDGE® 6020A High Current Systems

6011/1000/3000/5000/10000 Shunt Measurement Systems

As a shunt measurement system, the 6020/1000/3000/5000/10000 consists of a 6020/150 A module and the 6014/1000, 6014/3000 or 6014/10000 module. The system also features a built-in reversing switch and automatic ranging and is supplied in a rack on wheels for easy installation. Connection of the shunt is made at the side of the rack where two copper plates extend through the side panel. This effectively removes any heat loss due to poor connections to the shunt wires. In the high current shunt measurement system, the output current of the 6014 range extender (with a ratio of 1000:1) feeds directly into the 6011/150 A range extender as automatic ranging is performed inside the 6011/150 A. The 6011/150 A Range Extender is a precision DC Current Range Extender with ratios of 1000:1, 100:1 and 10:1. Used with the model 6014 ratios of 1,000,000:1 can be achieved.



6020/10000 A System

6020/6011/6014 Ranges	10 ⁻⁶ :1	10 ⁻⁵ :1	10 ⁻⁴ :1	10 ⁻³ :1	10 ⁻² :1	10 ⁻¹ :1
Currents	5000	5000	3000	100	10	1
6020/6011/6014 Uncertainties	5 ppm	5 ppm	2 ppm	0.41 ppm	0.31 ppm	0.21 ppm

The total power consumed is a result of the external load placed on the current sources. With a 2 V compliance, the power can be as high as 5000 A x 2 V = 6000 W if there are no losses in the leads. This type of power is high enough to raise the temperature in your calibration laboratory. As a result, MI recommends venting at the top of the rack directly into the ventilation system return to remove this heat from the laboratory if this is an issue.

Mounted on wheels, the 6020/1000/3000/5000/10000 can be moved about easily when required. Installation and operation is easy when used with the 6020 or 6242 Resistance Bridges.

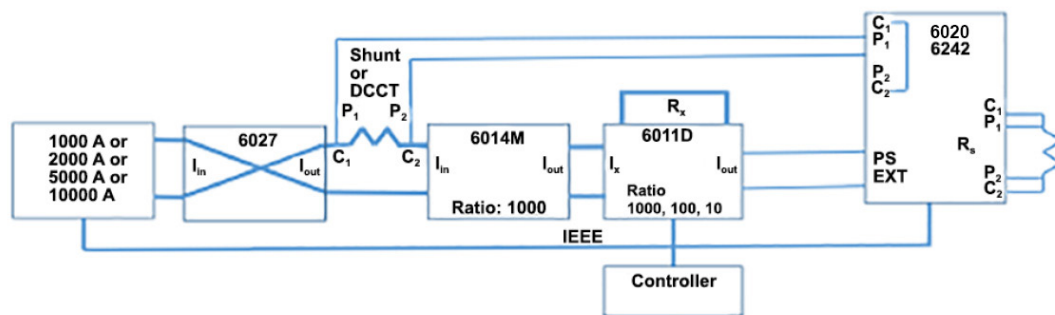

6020/10000 A Shunt Calibration System Schematic



ACCUBRIDGE® 6020A High Current Systems

6020/1000 A/3000 A/5000 A/10000 A Connections

The shunt is connected to the side of the rack where two copper plates extend through the side panel. This effectively removes any heat loss due to poor connections from using wire or cables to connect the shunt. In the high current shunt measurement system, the output current of the 6014M range extenders (with ratio of 1000:1) feeds directly into the 6011/150 A Range Extender as automatic ranging is performed inside the 6011/150.

Shunt Calibration 6020/6011 figure shows a 3000 A shunt connected to the 6020/3000 A terminals. Copper cars are used to extend the 6020/3000 A bus connections so that there is no heat loss in the connections or copper bars. This yields lower standard deviations in the measurements and is far superior to using cables. These copper bars can be supplied as an option with MI shunts.

9332/3000 A Shunt/10 $\mu\Omega$

Measurements International also manufactures a variety of shunts ranging from a 10 A (Model 9332/10) to 3000 A (Model 9332/3000/10 $\mu\Omega$). These shunts are designed so that the current is evenly distributed across the plates.

6011D/300 A Range Extender Figure shows a 9332/3000 A shunt with a thermocouple under normal and thermal imaging.

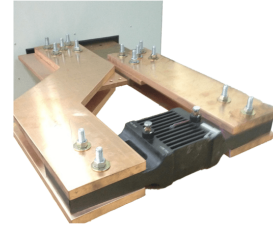

Shunt Connections

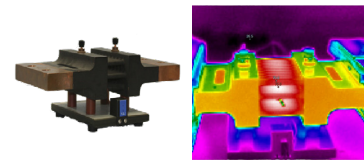

9332/3000
Normal and Thermal Image



ACCUBRIDGE® 6020A High Current Systems

Software

MI provides the best uncertainties in a shunt measurement system, and we offer a total solution in our 6020 or 6242 software. Not only does the software give you control over all the systems above, but it can also be used to interface to temperature/humidity and pressure modules for recording these parameters at the time of measurement. Data from all the measurements are stored in a text file which can be easily imported to Excel to plot both the shunt value and temperature/resistance curves for the shunt. Features of the software include the following:

1. Automatic control of all MI Bridges, Scanners, shunt measurement systems, calibrators, oil baths and air baths.
2. Importing calibration and measurement files to Excel.
3. Automatic calculation of temperature coefficients for up to 20 resistors at a time using a fixed bath and a variable bath.
4. Automatic measurements of air/oil bath temperatures.
5. Automatic measurements of the temperature of shunts.
6. Generation of temperature resistance graphs on shunt measurements.

Accessories

Model 4200 Series Matrix Scanners

An efficient method of reducing the cost of calibration, models offer 10, 16, and 20 channels with either binding posts or wire inputs.



Model 9332 Current Shunts

The Models 9332, DC Current Shunts are the latest development from the Measurements International series of DC resistors and shunts.



Model 9210 Primary Resistance Standard

Based on a specifically treated evanohm alloy, and using a proprietary process to improve stability and temperature coefficient, the 9210A is the most stable resistor commercially available. The long-term drift rate is better than 0.2 ppm per year and TC is less than 0.05 ppm/°C.



Model 9300A Standard Resistor Oil Bath

GPIB controllable and uses solid-state cooling, the 9300A is a cost-effective means to maintain the temperature up to 4 SR104's or 15 model 9331 air resistors from 15 °C to 40 °C with stability < 15 mK. Ideal for establishing temperature coefficients.



Model 9400 Standard Resistor Oil Bath

A stable and quiet oil bath with a capacity of 80 litres is used for the maintenance of oil resistors. The 9400 is Peltier-cooled and GPIB controllable. Also available is the optional 16-channel interconnect panel.



Cables

Measurements International can supply custom high current cables capable of handling any amperage up to and above 5000 A.

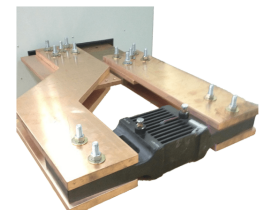



ACCUBRIDGE® 6020A High Current Systems

Specifications: Rev 3

Measurement Range	150 mA to 150 A	1 $\mu\Omega$ to 1 Ω
	150 mA to 10000 A	0.1 $\mu\Omega$ to 1 Ω
Linearity	± 0.01 ppm of full-scale	
Warm-Up Time to Full Rated Accuracy	1 minute	
Temperature Coefficient	0.01 ppm/°C	
Communication	IEEE-488	
Test Current Resolution	± 16 -bit	
Test Current Accuracy	0 to 150 A	± 1 %
	5 A to 150 A	± 1 %
	150 A to 10000 A	$\pm 0.1 + 450$ mA
Test Current Stability	0 A to 100 A	± 0.01 % of range + 1-bit for 8 hours
	100 A to 10000 A	$\pm 0.01 + 100$ mA
Compliance Voltage	0 to 150 A	4.2 V
	150 A to 10000 A	10 V
Operating Temperature to Full Specificaiton		
Maximum Operating Range (< 50 % RH)	+ 10 °C to + 40 °C	+ 50 °F to 104 °F
Temperature Storage Range	- 20°C to + 60 °C	- 4 °F to + 140 °F
Operating Humidity	20 % to 70 % RH	Storage Humidity 15 % to 80 % RH
Warranty	2 Years	

How to Order

- | | |
|------------------------------|-------------------------------|
| 1. Model 6020/150 A System | 9. Model 6242/150 A System |
| 2. Model 6020/300 A System | 10. Model 6242/300 A System) |
| 3. Model 6020/400 A System | 11. Model 6242/400 A System |
| 4. Model 6020/1000 A System | 12. Model 6242/1000 A System |
| 5. Model 6020/2000 A System | 13. Model 6242/2000 A System |
| 6. Model 6020/3000 A System | 14. Model 6242/3000 A System |
| 7. Model 6020/5000 A System | 15. Model 6242/5000 A System |
| 8. Model 6020/10000 A System | 16. Model 6242/10000 A System |

Accessories

1. Thermocouple Reader (1 to 4 Channels)
2. Model 9332 Shunt, 10 A to 3000 A (100 m Ω to 10 $\mu\Omega$)
3. Shunt Extension Copper Plates
4. 4220A/30 A 4 Terminal Scanner
5. SPSCW-4 30 M (4-conductor)
6. SPSCW-4 100 M (4-conductor)

Dimensions (L x W x H):

Subject to system configuration

Weight:

Subject to system configuration

Shipping Weight:

Subject to system configuration

Main Power:

Subject to destination country

Corporate Headquarters

Measurements International
PO Box 2359, 118 Commerce Drive
Prescott, Ontario, Canada K0E 1T0

Phone: 613-925-5934

Fax: 613-925-1195

Email: sales@mintl.com

Toll Free: 1-800-324-4988

